

# 1 Safety Instruction

## IMPORTANT SAFEGUARDS

When using electrical products, especially when children are present, basic safety precautions should always be followed, including the following:

### READ ALL INSTRUCTIONS BEFORE USING

#### INSTALLATION

- In the case 120V 60Hz: Power supply must be a 15Amp GFCI outlet.
- The electrical cord is a minimum of 3 ft. long.
- The electrical cord must be connected to a GFCI outlet.
- The GFCI outlet should be 1 ft. above the floor.
- Install only in well-ventilated areas to avoid excess humidity.
- Do not install in narrow toilet stalls or in shower stalls.
- Install only where direct contact with water is minimized.
- Do not install near any heat source.
- Avoid using extension cords if possible. Consult with a certified electrician where extension cords are necessary.

#### DANGER

To reduce the risk of electrocution:

- 1 Do not use while bathing.
- 2 Do not place or store product where it can fall or be pulled into a tub or sink.
- 3 Do not place in or drop into water or other liquid.
- 4 Do not reach for a product that has fallen into water. Unplug immediately.

#### WARNING

To reduce the risk of burns, electrocution, fire, or injury to persons.

- 1 Close supervision is necessary when this product is used by, on, or near children or those with limited mobility.
- 2 Use this product only for its intended use as described in this manual. Do not use attachments not recommended by the manufacturer.
- 3 Never operate this product if it has a damaged cord or plug, if it is not working properly, if it has been dropped or damaged, or dropped into water. Return the product to a service center for examination and repair.
- 4 Keep the cord away from heated surfaces.
- 5 Never use while drowsy.
- 6 Never drop or insert any object into any opening or hose.
- 7 Do not use outdoors or operate where aerosol (spray) products are being used or where oxygen is being administered.
- 8 Connect this product to a properly grounded outlet only. See Grounding Instructions.
- 9 When using for the first time, please follow instructions.

SAVE THESE INSTRUCTIONS

## GROUNDING INSTRUCTIONS

This product should be grounded. In the event of an electrical short circuit, grounding reduces the risk of electric shock by providing an escape wire for the electric current. This product is equipped with a cord having a grounding wire with a grounding plug. The plug must be plugged into an outlet that is properly installed and grounded.

#### DANGER

Improper use of the grounding plug can result in a risk of electric shock.

When repairing or replacing the cord or plug, do not connect the grounding wire to either flat blade terminal. The wire with insulation, having an outer surface that is green with or without yellow stripes, is the grounding wire. Check with a qualified electrician or serviceman if the grounding instructions are not completely understood, or if in doubt as to whether the product is properly grounded.

**Grounded, cord-connected products, rated 15 A or more, intended for use on a nominal 120 V supply circuit.** This product is for use on a nominal 120 V circuit, and has a grounding plug that looks like the plug illustrated in Figure 1(A). A temporary adapter, which looks like the adapter illustrated in Figure 1(B) and (C), may be used to connect this plug to a 2-pole receptacle as shown in Figure 1(B), if a properly grounded outlet is not available.

The temporary adapter should be used only until a properly grounded outlet, Figure 1(A), can be installed by a qualified electrician. The green tab, nut or other connector extending from the adapter must be connected to a permanent ground, such as a properly grounded outlet box cover. Whenever the adapter is used, it must be held in place by the screw.

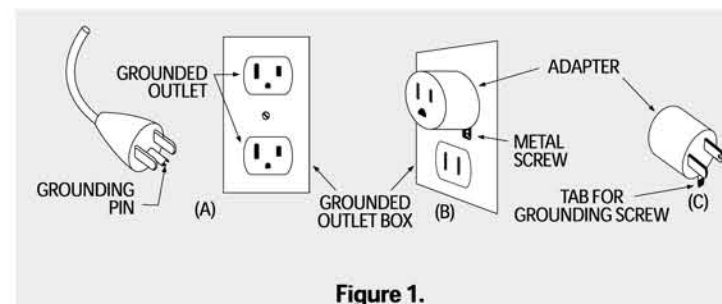

Figure 1.

# 2 Product Characteristic

#### Instant Heating

Enjoy continuous warm water with our new Instant Heating technology.



#### Easy Button (Toggle Switch)

One button can handle double functions easily. (Func. + Massage)



#### Bubble Wash

Aerated water wash adds cleaning comfort.



#### Hot/Cold Cycle Wash

Hot and cold water cycles for hydrotherapy use.



#### Energy Saving Function

Energy saving function minimizes power usage.



#### Automatic Dry

Automatic dry after Wash & Bidet provides convenient and easy use.



#### Pulse

Pulsating wash repeatedly cycles from weak to strong.



#### Massage

Nozzle moves back and forth for massage effect.



#### Vertical Nozzles

Improved hygiene for female users.



#### Precision Nozzle Control

Nozzle position can be controlled incrementally.

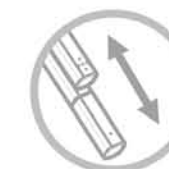

#### Child Settings

Specialized nozzle position and water pressure for children



#### Sitz Bath

Sitz bath (warm water) continues for 5 min. - from bidet nozzle.



# 3 Designation of Each Component

#### Main Body

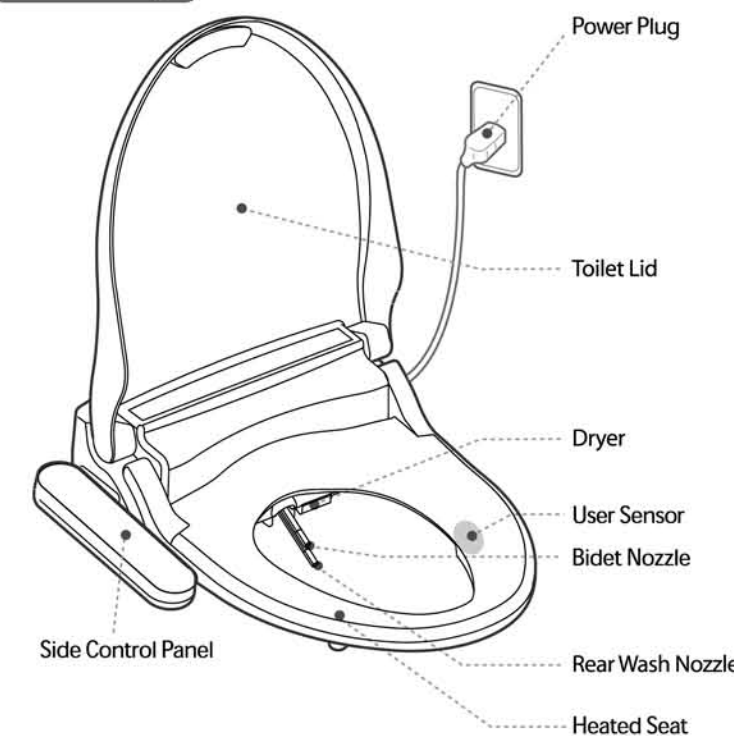

#### Accessories

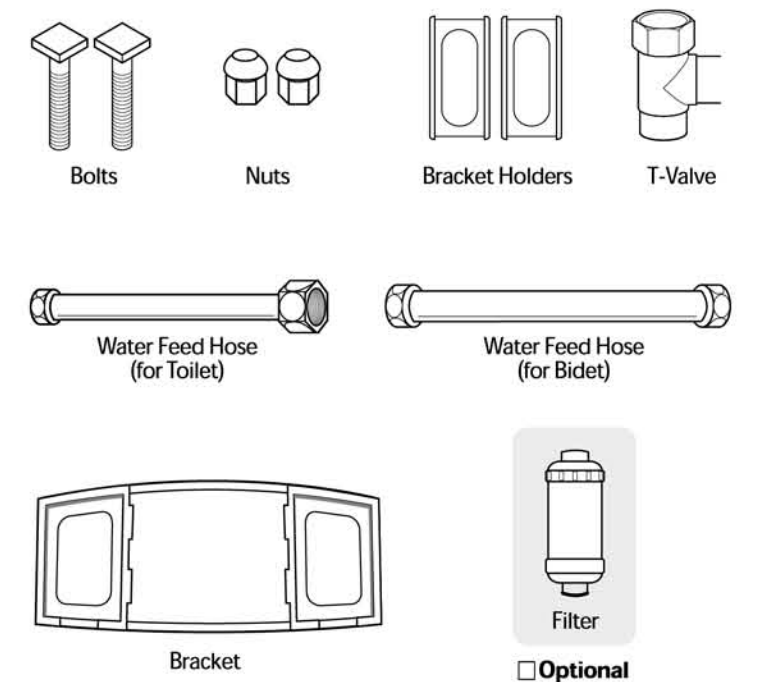

## 4 Operation Panel

### ENERGY SAVING

**On (yellow)** : Energy saving mode keeps the seat at a lower temperature.  
**Off** : Cancel the energy saving mode.

### SILENT MODE

Press "STOP" + "Energy Saving" buttons together for silent mode.

### SEAT TEMP

Adjust seat temperature.  
**OFF** - Room Temp, **Green** - LOW  
**Yellow** - MEDIUM, **Red** - HIGH

### WATER TEMP

Adjust wash water temperature.  
**OFF** - Room Temp, **Green** - LOW  
**Yellow** - MEDIUM, **Red** - HIGH

### WATER PRESSURE

Adjust water pressure.  
**OFF**, **Green** - LOW, **Yellow** - MEDIUM  
**Red** - HIGH

### NOZZLE POSITION

Adjust nozzle position.  
Push or keep pressing the button to change the position.

### PULSE

Pulsating water stream (strong / weak).  
Use with WASH / BIDET.

### WASH

Wash function (2 minutes).  
After full wash, warm air dry starts automatically and runs for 1 min.  
Press button again for massage wash.

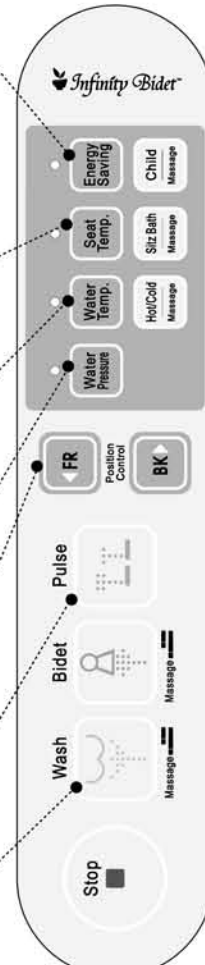

[XLC-1000]

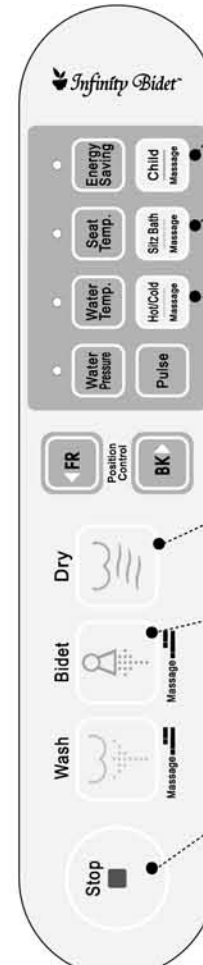

[XLC-2000]

### CHILD

Children Safety Mode Nozzle moves forward.  
Water Pressure and Seat temperature are reduced.

### SITZ BATH

Sitz bath - warm water for 5 minutes.  
- from bidet nozzle.  
After full wash, warm air dry starts automatically and runs for 1 minute.

### HOT/COLD

Hot and cold water cycle wash alternates between room temperature and warm water for hydrotherapy.  
After full wash, warm air dry starts automatically and runs for 1 minute.

### DRY

Dry function (3 minutes). [XLC-2000 only]

### BIDET

Bidet function (2 minutes).  
After full wash, warm air dry starts automatically and runs for 1 minute.  
Press button again for massage wash.

### STOP

Stops all functions.  
Press STOP button for 3 seconds to power-off.  
Press Wash or Bidet button to power-on.

## 5 Order of Installation

### 1 Attach the bracket onto the toilet.

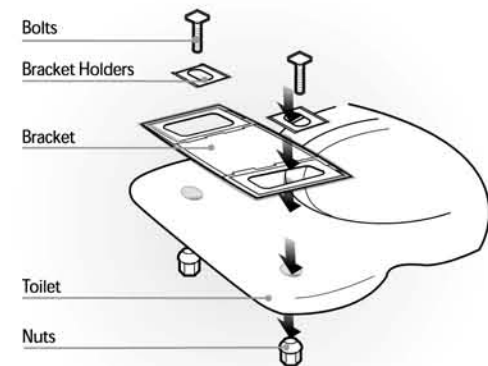

▶ Before fastening the nuts, move the seat and the front part of the toilet back and forth until they are aligned.

### 2 Push the main body toward the bracket completely.

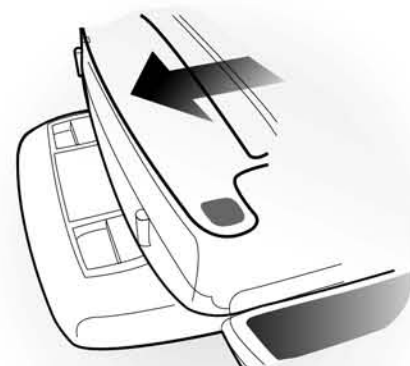

▶ **IMPORTANT!** Push in until you hear it 'click.'

### 3 Install T-valve and hose as shown in figure below.

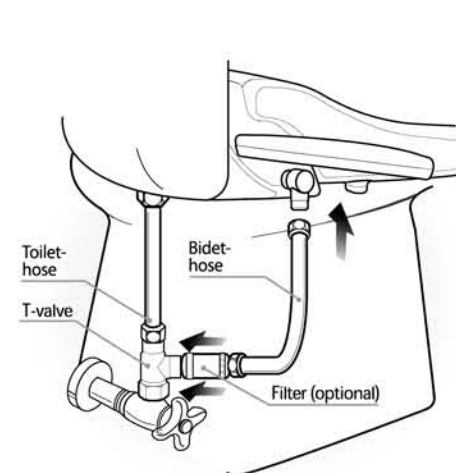

## 6 Maintenance & Cleaning

### Cleaning of Water pipe filter

- 1 Close the water feed valve by turning it clockwise.
- 2 Disconnect the water supply hose. Take the screen filter out and clean it with soft brush. (e.g. toothbrush)
- 3 Return screen after cleaning and reconnect the water supply hose.
- 4 Open the water feed valve by turning it counter-clockwise.

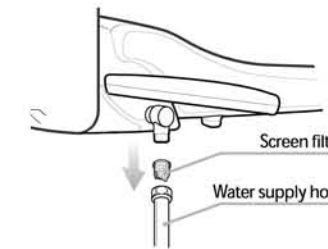

### Cleaning of Nozzle

- 1 Press the WASH/BIDET button for 3 seconds. The nozzle will move forward and stop for 2 minutes.
- 2 Clean the nozzle with an unused toothbrush, then press the STOP button. Nozzle will return to its original position.



### Cleaning of Bidet Body

- 1 Exterior surface of bidet is made of a plastic material, which may be damaged by stiff scrubbers, chemicals, etc.
- 2 Wipe the surface with a soft, damp cloth which has been wrung out completely. Do not spray water directly onto the surface of the bidet.
- 3 Clean the body only after removing the power plug from the outlet. Be sure no water splashes the power plug or outlet.
- 4 Don't touch the power outlet with a wet hand. This creates a risk of electric shock.

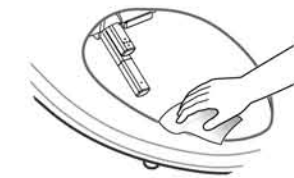

## 8 Product Specifications

Item	XLC-2000	
Rated Voltage	120V ~, 60 Hz	
Max. Consumption Power	1,250W	
Power Cord Length	4ft	
Water Feed Method	Directly Connected to Water Pipe	
Water Pressure	10.6 - 106.6 psi	
Wash	Feeding Volume Wash	0.14 gal/min
	Bidet	0.14 gal/min
	Water Pressure Control	4 Steps Control
	Temp. Control	Room Temp. - 102°F
Heated Seat	Heater Capa.	1,200W
	Safety Device	Temp. Fuse, Thermo Switch
Dry	Temp. Control	Room Temp. - 100°F
	Heater Capa.	55W
	Safety Device	Temp. Fuse
Product Dimension	Elongated	18.5" x 20.8" x 5.7"
	Round front	18.5" x 19.5" x 5.7"
	Small	18.5" x 18.5" x 5.7"
	Product Weight (Gross Weight)	Elongated
	Round front	10lb (16.2lb)
	Small	9.8lb (16lb)

## 7 Before Requesting Repair

Please check the following before requesting repair of this product.

Problem	Check
Bidet seat does not operate	<ul style="list-style-type: none"> <li>• Make sure the power plug is connected.</li> <li>• Make sure it is not the result of a power failure.</li> </ul>
Water does not spray	<ul style="list-style-type: none"> <li>• Make sure the water supply is operational.</li> <li>• Make sure water feed valve is unlocked.</li> <li>• Make sure the nozzle is not blocked (by foreign material).</li> <li>• Make sure the connection hose is not bent.</li> </ul>
Water pressure is low	<ul style="list-style-type: none"> <li>• Make sure the water pipe filter is not blocked (by foreign material).</li> <li>• Make sure the water pressure is not set too low.</li> </ul>
Water is not warm enough	<ul style="list-style-type: none"> <li>• Make sure the temperature is not set to 'OFF' or 'LOW'</li> </ul>
Seat is not warm enough	<ul style="list-style-type: none"> <li>• Make sure the temperature is not set to 'OFF' or 'LOW'</li> </ul>

### Self-Diagnosis Table

No	Indicator	Problem
1	LED for Water Pressure blinks (Red / 0.5 sec.)	Instant Heating Module disconnected
2	LED for Water Temp. blinks (Green / 1 sec.)	Inlet hot water sensor disconnected
3	LED for Water Temp. blinks (Green / 0.5 sec.)	Inlet hot water sensor short-circuited
4	LED for Water Temp. blinks (Red / 1 sec.)	Outlet hot water sensor disconnected
5	LED for Water Temp. blinks (Red / 0.5 sec.)	Outlet hot water sensor short-circuited
6	LED for Water Temp. blinks (Red / 0.5 sec.)	Outlet hot water sensor indicates over 113 °F
7	LED for all func. blinks (Green / 0.5 sec.)	Main PCB error
8	LED for Water Pressure blinks (Green / 0.5 sec.)	Water flow meter disconnected
9	LED for Seat Temp. blinks (Green / 1 sec.)	Seat Temp. sensor disconnected
10	LED for Seat Temp. blinks (Red / 1 sec.)	Seat Temp. sensor short-circuited

## Bidet Seat 1-Year Limited Warranty

(For Customers in the United States)

1. All warranty service will be provided by our Factory Service Center.
2. Warranty covers any part of the bidet seat which fails due to a defect in materials or workmanship.
3. During this **limited one-year warranty**, Infinity Bidet will also provide, **free of charge**, all labor and related service to replace the defective part.

### What Infinity Bidet Will Not Cover:

- Service trips to your home.
- Improper installation, delivery or maintenance.
- Failure of the product due to abuse, misuse or use for other than the intended purpose.
- Use of the product for commercial purposes.
- Damage caused after delivery.
- Damage to the product caused by accident, fire, floods, or acts of God.
- Incidental or consequential damage caused by possible defects with this product.

**EXCLUSION OF IMPLIED WARRANTIES**-Your sole and exclusive remedy is product repair as provided in this Limited Warranty. Any implied warranties, including the implied warranties of merchantability or fitness for a particular purpose, are limited to one year or the shortest period allowed by law.

This warranty is extended to the original purchaser and any succeeding owner for products purchased for home use within the USA. If the product is located in an area where service by our Factory Service Center is not available, you may be responsible for a trip charge or you may be required to bring the product to an authorized service facility for service. The warranty excludes the cost of shipping to a service facility.

 71 Ruths Place, Suite #8, Sequim, WA 98382 USA  
Tel : 1-800-681-0753 Fax : 1-800-681-4029  
[www.infinitybidet.com](http://www.infinitybidet.com)